

Power Operational Amplifiers

FEATURES

- Low Cost
- Wide Common Mode Range
- Standard Supply Voltage
- Single Supply: 10V to 50V SMPS input
- Output Current: 150 mA Continuous
- Output Voltage 50V to 340V (single supply)
- 350 V/ μ s Slew Rate
- 200 kHz Power Bandwidth
- On-board Power Supply



APPLICATIONS

- Piezoelectric Positioning and Actuation
- Electrostatic Deflection
- Deformable Mirror Actuators
- Chemical and Biological Stimulators

DESCRIPTION

The MP400FC combines a high voltage, high speed precision power op amp with a supply voltage boost function in an integrated thermally conductive module. The voltage boost function uses a switch mode power supply (SMPS) to boost the input power supply voltage. This allows the user the benefits of using a standard 12 V or 24 V bus without the need to design a high voltage supply to power the op amp. The SMPS voltage is adjustable from 50-350 V, allowing for op amp output voltages up to 340 V. External phase compensation provides the user with the flexibility to tailor gain, slew rate and bandwidth for a specific application. The unique design of this amplifier provides extremely high slew rates in pulse applications while maintaining low quiescent current. The output stage is well protected with a user defined current limit. Safe Operating Area (SOA) must be observed for reliable operation.

Figure 1: Equivalent Schematic

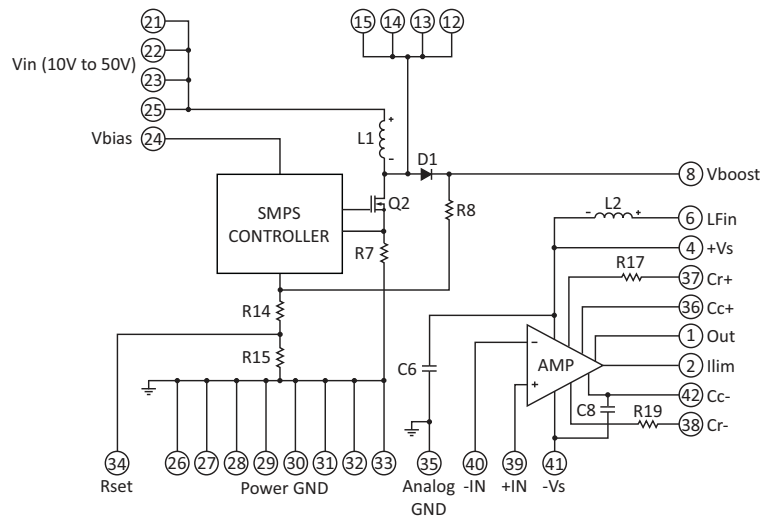

TYPICAL CONNECTION

Figure 2: Typical Connection

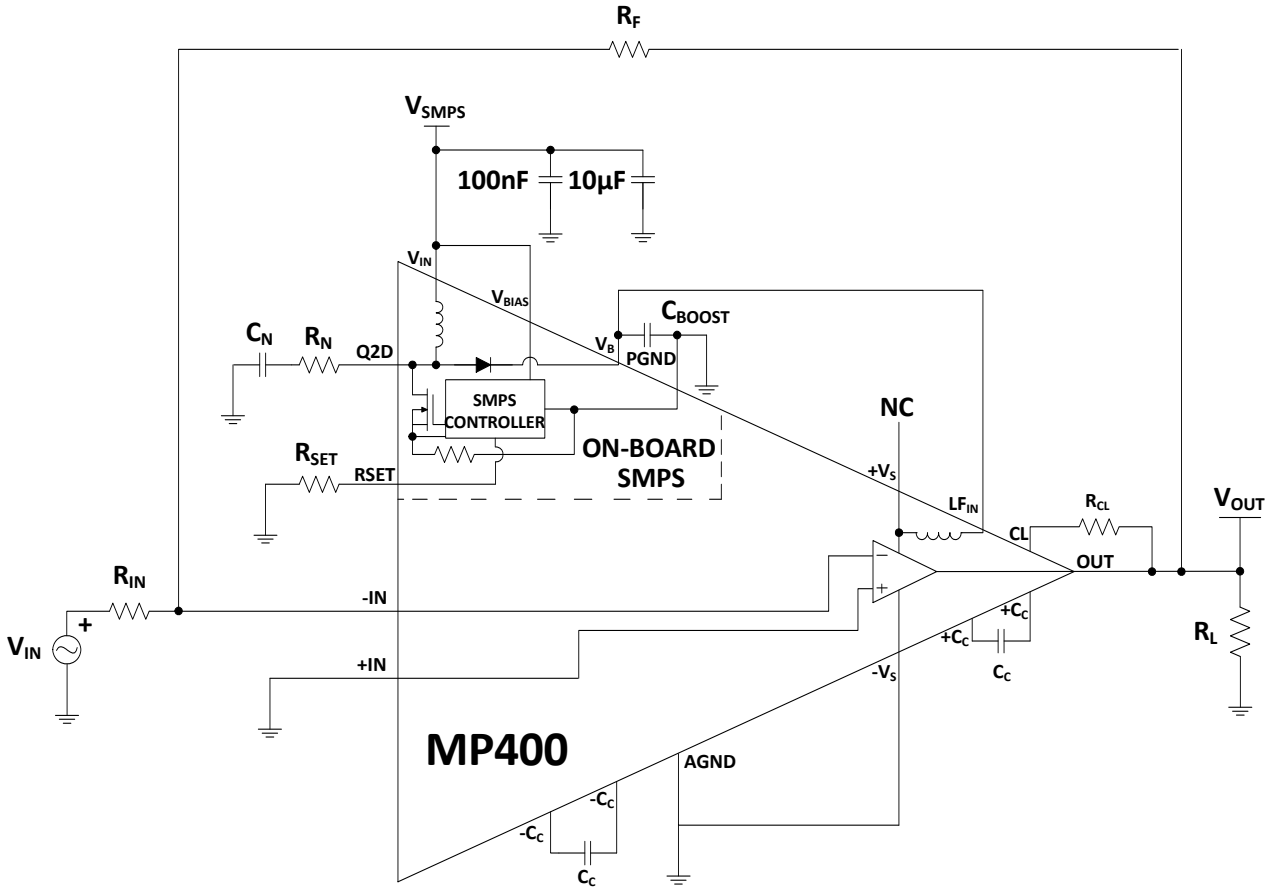

PINOUT AND DESCRIPTION TABLE

Figure 3: External Connections

| | | | | |
|-----------|-----------|---|------------|-----------|
| | | | C_C | <u>42</u> |
| | | | $-V_S$ | <u>41</u> |
| <u>1</u> | OUT | | -IN | <u>40</u> |
| <u>2</u> | CL | | +IN | <u>39</u> |
| <u>3</u> | NC | | C_R | <u>38</u> |
| <u>4</u> | $+V_S$ | | C_{R+} | <u>37</u> |
| <u>5</u> | NC | | C_{C+} | <u>36</u> |
| <u>6</u> | LF_{IN} | | AGND | <u>35</u> |
| <u>7</u> | NC | | RESET | <u>34</u> |
| <u>8</u> | V_B | MP400 (from backplate) | PGND | <u>33</u> |
| <u>9</u> | NC | | PGND | <u>32</u> |
| <u>10</u> | NC | | PGND | <u>31</u> |
| <u>11</u> | NC | | PGND | <u>30</u> |
| <u>12</u> | Q2D | | PGND | <u>29</u> |
| <u>13</u> | Q2D | | PGND | <u>28</u> |
| <u>14</u> | Q2D | | PGND | <u>27</u> |
| <u>15</u> | Q2D | | PGND | <u>26</u> |
| <u>16</u> | NC | | V_{IN} | <u>25</u> |
| <u>17</u> | NC | | V_{BIAS} | <u>24</u> |
| <u>18</u> | NC | | V_{IN} | <u>23</u> |
| <u>19</u> | NC | | V_{IN} | <u>22</u> |
| <u>20</u> | NC | | V_{IN} | <u>21</u> |

Unused pins should be left open. This is mandatory for pins 3, 5, 7, 9, 11 and 16.

| Pin Number | Name | Description |
|----------------|-----------|--|
| 1 | OUT | The output. Connect this pin to load and to the feedback resistor. |
| 2 | CL | Connect to the current limit resistor, and then the OUT pin. Output current flows into/out of this pin through R_{CL} . |
| 4 | $+V_S$ | The positive supply rail. Leave open when using on-board SMPS. |
| 6 | LF_{IN} | The supply filter. When using the on-board SMPS, connect this pin to V_B to power the amplifier. This filters the SMPS current through a 47 μ H inductor. The current to this pin can not exceed 200 mA. See applicable section. |
| 8 | V_B | This is the output of the high voltage SMPS and typically is tied to pin 6, LF_{IN} . Other loads can be added to this pin as long as the maximum output power of the SMPS is not exceeded. For proper operation, an external high voltage, low ESR capacitor must be connected to this pin. See applicable section. |
| 12, 13, 14, 15 | Q2D | Drain node of the SMPS MOSFET switch. An external RC snubber may be connected from this node to power ground to reduce or eliminate overshoot and ringing at switch turn off, reducing switching noise on the SMPS. |
| 21, 22, 23, 25 | Vin | Input voltage pins for the on-board high voltage switch mode power supply. Supply with 10-50 V. |
| 24 | Vbias | Input voltage pin for the boost controller circuitry. This pin is typically tied to V_{IN} . |

MP400FC



| Pin Number | Name | Description |
|------------|------|---|
| 26-33 | PGND | Power ground. SMPS switching circuits are referenced to ground through these pins. |
| 34 | RSET | SMPS voltage set resistor connecton. The 'Set Resistor' is connected from this pin to PGND to set the SMPS voltage. Select value based on desired V_{BOOST} . See applicable section. |
| 35 | AGND | Analog ground for amplifier circuit. AGND and PGND are connected at one point on the unit. Avoid external connections between AGND and PGND. |
| 36, 37 | +CC | Positive compensation capacitor connection. Select value based on Phase Compensation. See applicable section. |
| 38, 42 | -CC | Negative compensation capacitor connection. Select value based on Phase Compensation. See applicable section. |
| 39 | +IN | The non-inverting input. |
| 40 | -IN | The inverting input. |
| 41 | -Vs | The negative supply rail. This pin is typically connected to AGND. However, an external negative supply voltage can be connected to this pin. |
| All Others | NC | No connection. |

SPECIFICATIONS

All Min/Max characteristics and specifications are guaranteed over the Specified Operating Conditions. Typical performance characteristics and specifications are derived from measurements taken at typical supply voltages and $T_C = 25^\circ\text{C}$. $+V_S$ and $-V_S$ denote the positive and negative supply voltages to the output stage.

ABSOLUTE MAXIMUM RATINGS

| Parameter | Symbol | Min | Max | Units |
|--|---------------------------|--------|--------|------------------|
| Supply Voltage, Total, SMPS | $+V_{\text{SMPS}}$ to GND | | 50 | V |
| Supply Voltage, Total, Amplifier | $+V_S$ to $-V_S$ | | 350 | V |
| Output Current, peak within SOA | I_O | | 200 | mA |
| Power Dissipation, Internal, DC, Amplifier | P_D | | 14.2 | W |
| Output Power, SMPS | $P_{\text{OUT, SMPS}}$ | | 67 | W |
| Input Voltage, differential | $V_{\text{IN (Diff)}}$ | -16 | +16 | V |
| Input Voltage, common mode | V_{cm} | $-V_S$ | $+V_S$ | V |
| Temperature, pin solder, 10s max. | | | 225 | $^\circ\text{C}$ |
| Temperature, junction ¹ | T_J | | 150 | $^\circ\text{C}$ |
| Temperature Range, storage | | -40 | +105 | $^\circ\text{C}$ |
| Operating Temperature Range, case | T_C | -40 | +85 | $^\circ\text{C}$ |

1. Long term operation at the maximum junction temperature will result in reduced product life. Derate power dissipation to achieve high MTTF.

AMPLIFIER INPUT

| Parameter | Test Conditions | Min | Typ | Max | Units |
|------------------------------------|--------------------------------|-----|--------------|-----|------------------------------|
| Offset Voltage, initial | | | 8 | 40 | mV |
| Offset Voltage vs. Temperature | 0 to 85°C (Case) | | -63 | | $\mu\text{V}/^\circ\text{C}$ |
| Offset Voltage vs. Supply | | | | 32 | $\mu\text{V}/\text{V}$ |
| Bias Current, initial ¹ | | | 8.5 | 200 | μA |
| Offset Current, initial | | | 12 | 400 | μA |
| Input Resistance, DC | | | 10^6 | | Ω |
| Common Mode Voltage Range, pos. | | | $+V_S - 2$ | | V |
| Common Mode Voltage Range, neg. | | | $-V_S + 5.5$ | | V |
| Common Mode Rejection, DC | | 90 | 118 | | dB |
| Noise | 700 kHz bandwidth | | 418 | | $\mu\text{V RMS}$ |

1. Doubles for every 10°C of temperature increase.

AMPLIFIER GAIN

| Parameter | Test Conditions | Min | Typ | Max | Units |
|---------------------------------------|---|-----|-----|-----|-------|
| Open Loop @ 15 Hz | | 89 | 120 | | dB |
| Gain Bandwidth Product @ 1 MHz | | | 1 | | MHz |
| Power Bandwidth, 300 V _{P-P} | +V _S = 160 V, -V _S = -160 V | | 200 | | kHz |
| Phase Margin | Full temp range | | 50 | | ° |

AMPLIFIER OUTPUT

| Parameter | Test Conditions | Min | Typ | Max | Units |
|------------------------------------|--------------------------|-----|------------------------|-----------------------|-------|
| Voltage Swing | I _O = 10 mA | | V _S - 2 | | V |
| Voltage Swing | I _O = 100 mA | | V _S - 8.6 | V _S - 12 | V |
| Voltage Swing | I _O = 150 mA | | V _S - 10 | | V |
| Current, continuous, DC | | 150 | | | mA |
| Slew Rate | | 100 | 350 | | V/μs |
| Settling Time, to 0.1% | 2 V Step | | 1 | | μs |
| Resistance, No load | R _{LIM} = 6.2 Ω | | 44 | | Ω |
| Current, quiescent, amplifier only | | 0.2 | 0.7 | 2.5 | mA |

SMPS

| Parameter | Test Conditions | Min | Typ | Max | Units |
|-------------------------------------|--|-------|------|-----|-----------|
| Input Voltage, V _{IN} | | 10 | | 50 | V |
| SMPS Output Voltage, V _B | | 46.75 | | 365 | V |
| SMPS Output Current, I _S | V _B = 10x V _{IN} | 150 | | | mA |
| Output Voltage Tolerance | V _B ≤ 10x V _{IN} , I _S ≤ 150 mA, R _{SET} = 1% | | +/-2 | 6.5 | % |
| Voltage Boost | | | 10 | | x input V |

THERMAL

| Parameter | Test Conditions | Min | Typ | Max | Units |
|----------------------------------|----------------------------|-----|-----|-----|-------|
| Resistance, DC, junction to case | Full temp range, f < 60 Hz | | 7.7 | 8.8 | °C/W |
| Resistance, junction to air | Full temp range | | 46 | | °C/W |
| Temperature Range, case | | 0 | | 70 | °C |

TYPICAL PERFORMANCE GRAPHS

Figure 4: Power Response

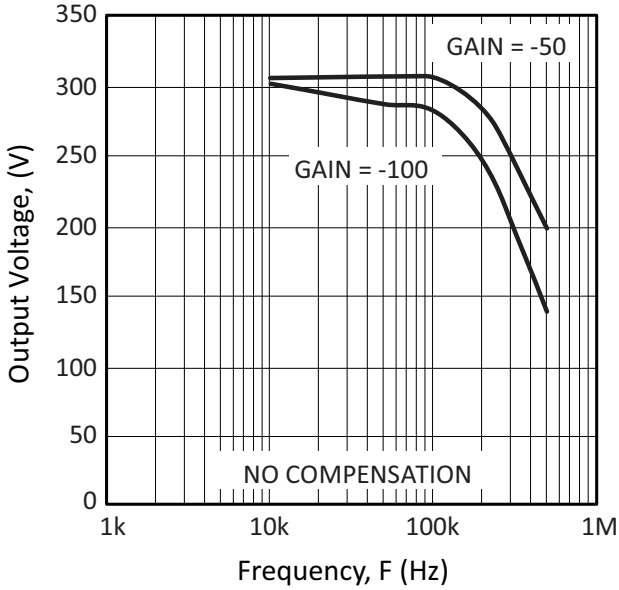

Figure 5: Current Limit

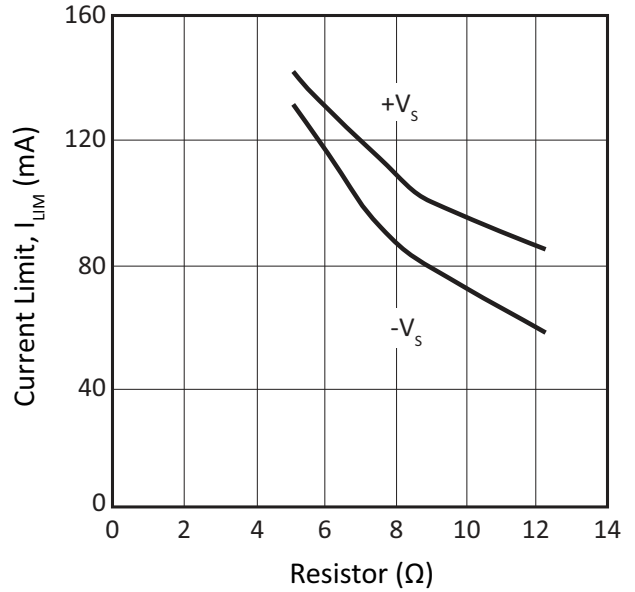

Figure 6: Power Supply Rejection

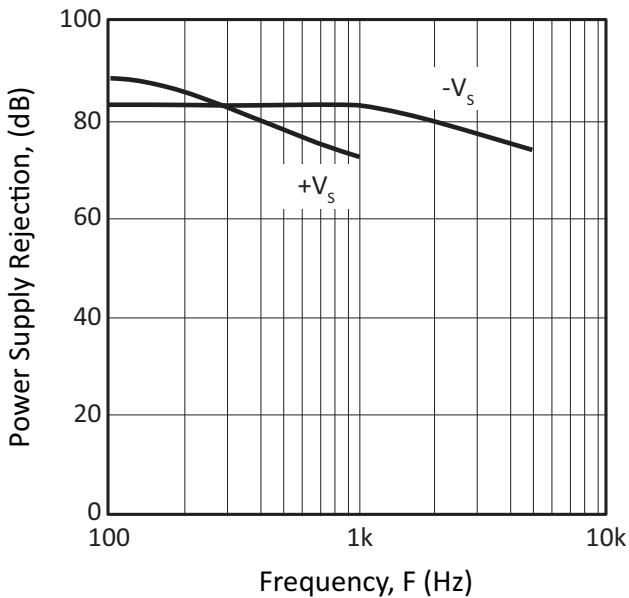

Figure 7: Amplifier Internal Power Derating

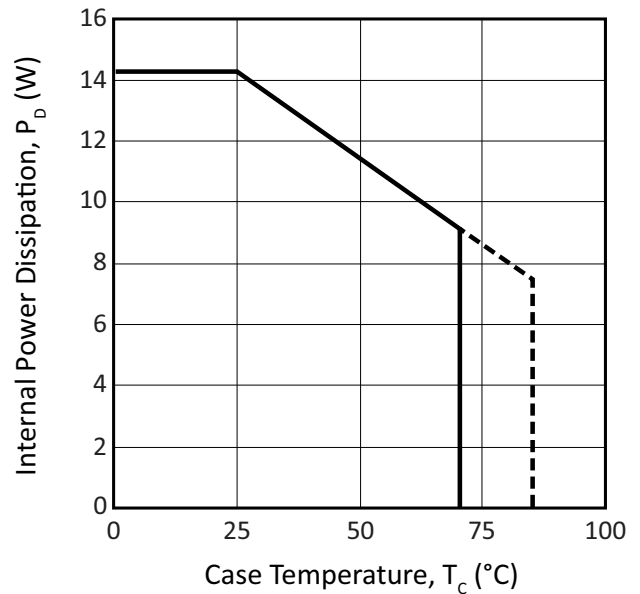

Figure 8: Output Voltage Swing

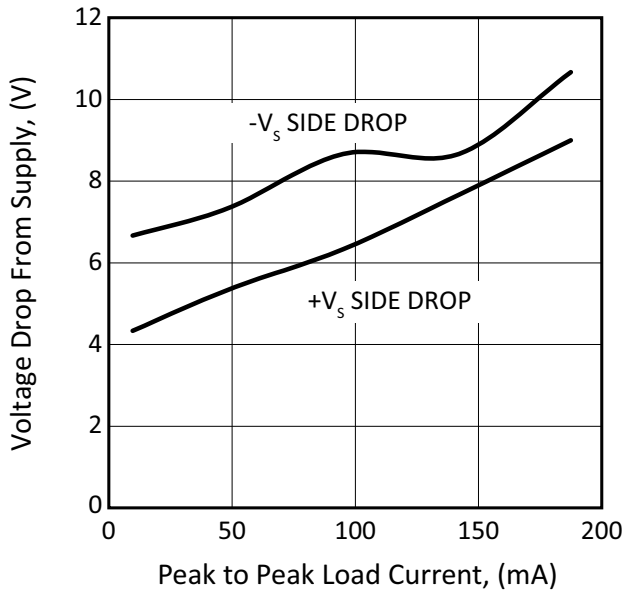

Figure 9: Common Mode Rejection

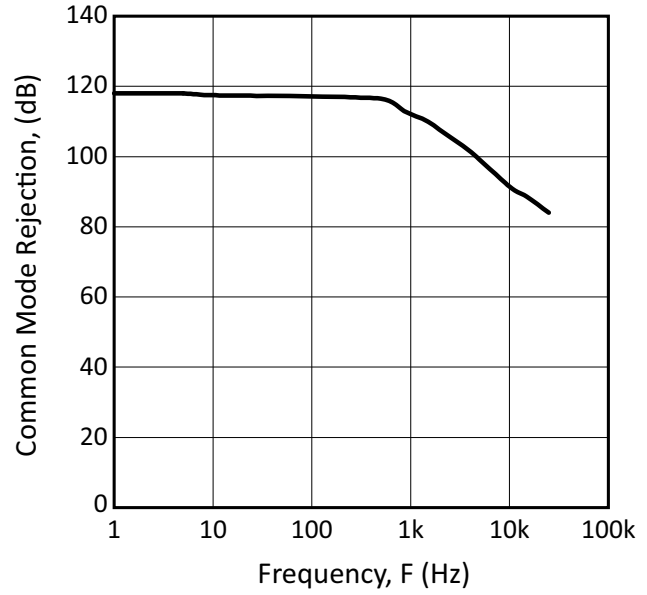

Figure 10: Efficiency vs. SMPS Current

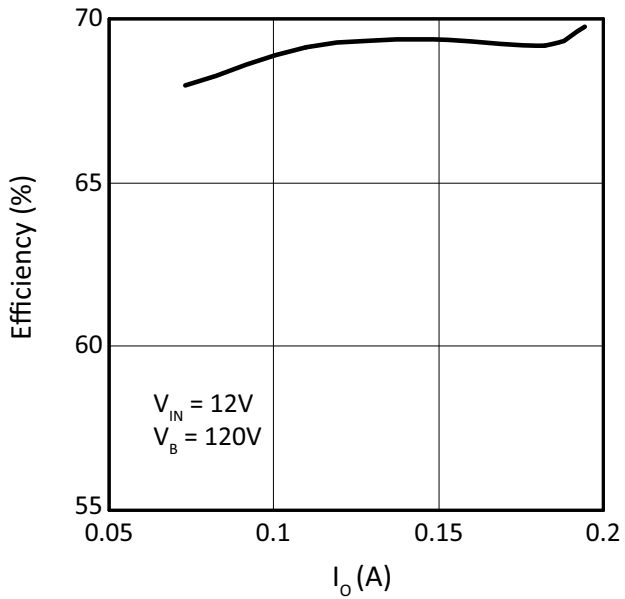

Figure 11: Efficiency vs. SMPS Current

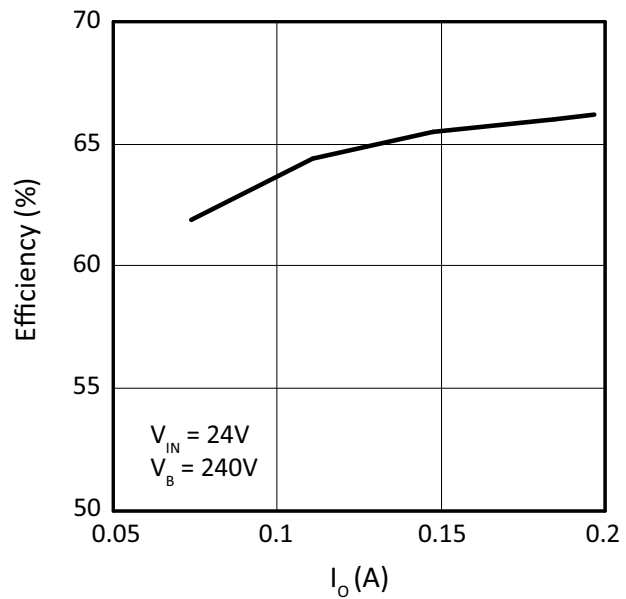

Figure 12: Efficiency vs. SMPS Current

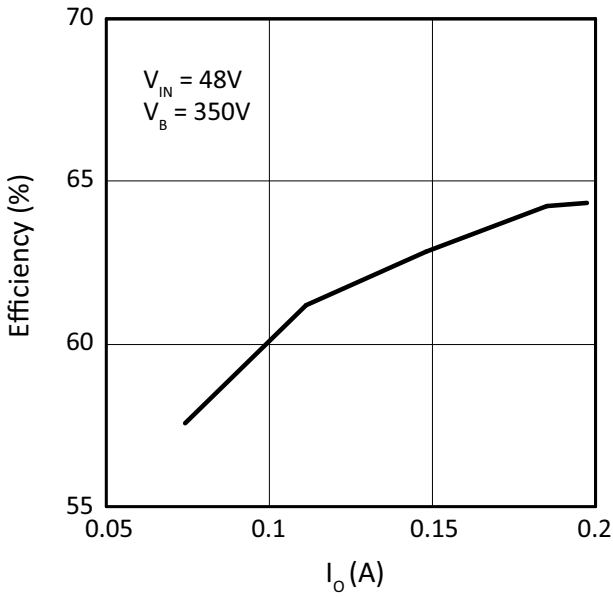

Figure 13: SMPS Current vs. SMPS Voltage

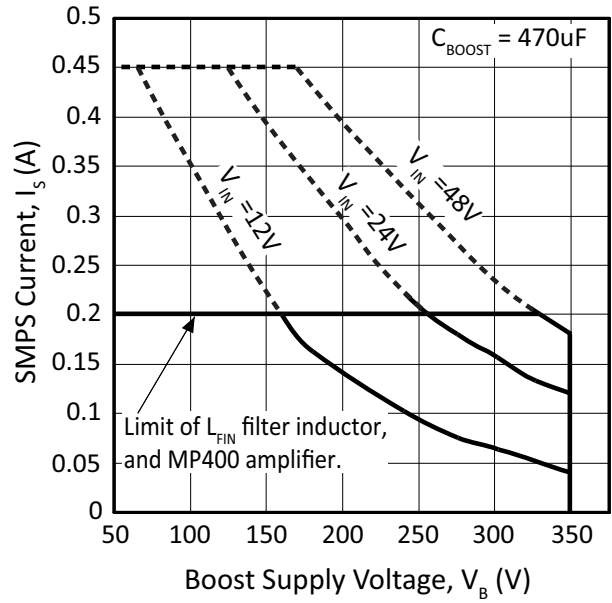

Figure 14: SMPS Power Derating

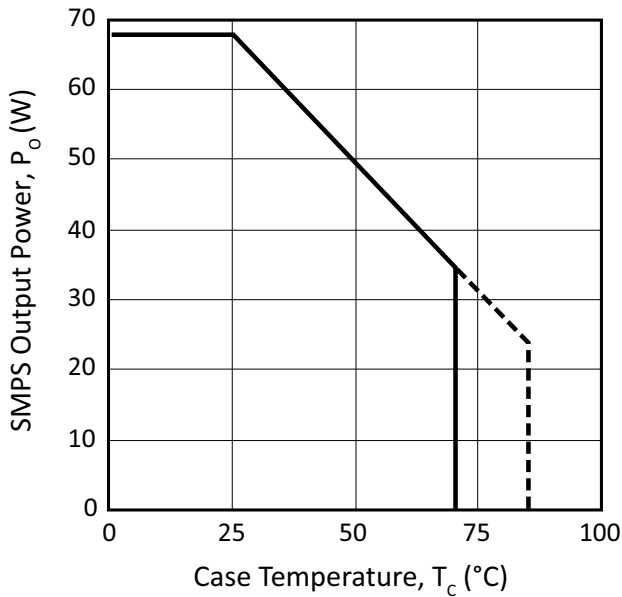

Figure 15: Pulse Response vs. Cap Load

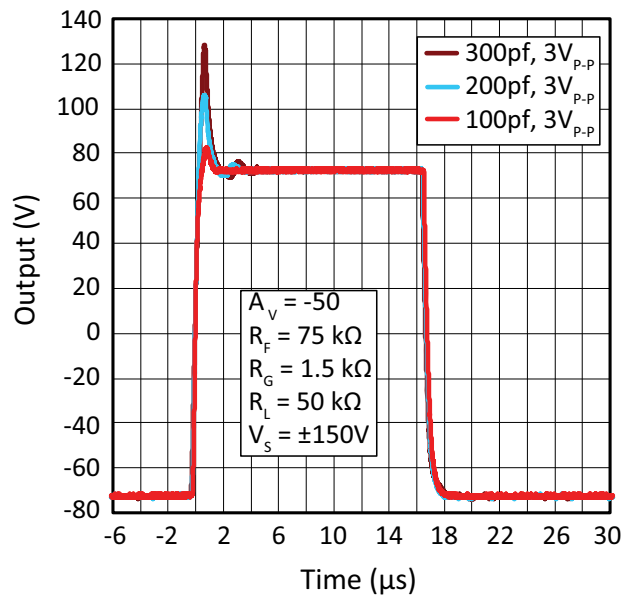

Figure 16: Pulse Response vs. Cap Load

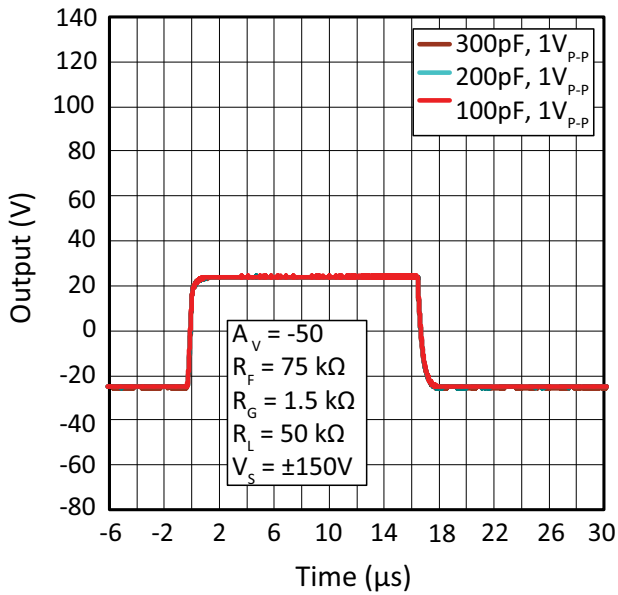

Figure 17: Pulse Response vs. Cap Load

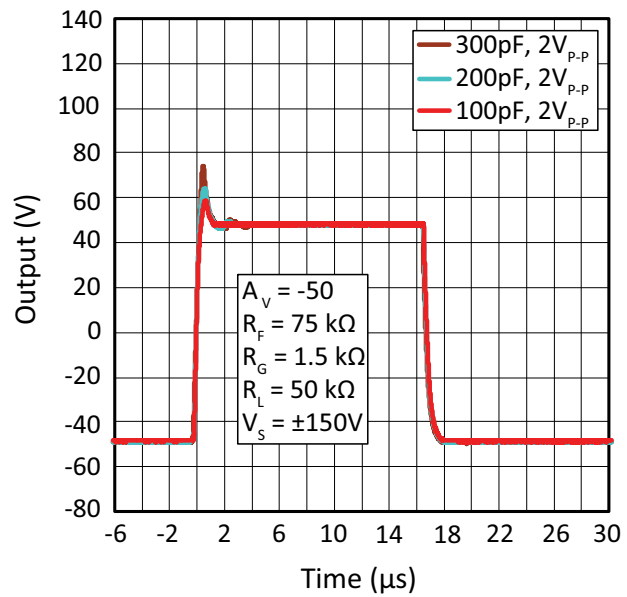

Figure 18: Small Signal Open Loop Gain

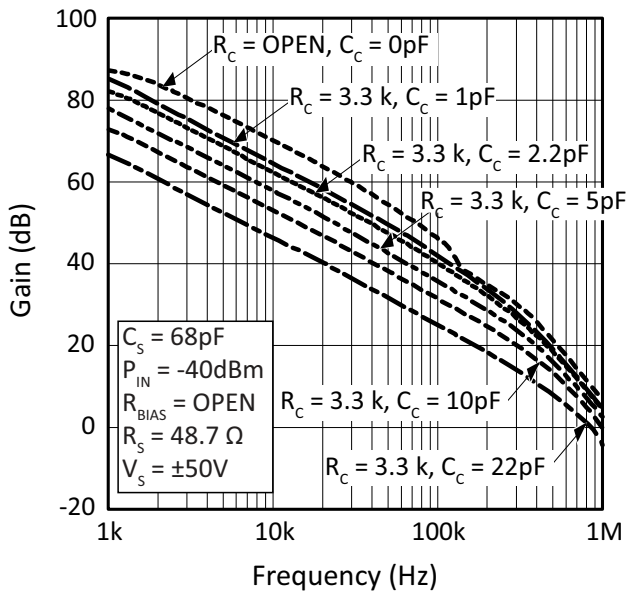

Figure 19: Small Signal Open Loop Phase, $V_O=250\text{mV}_{p-p}$

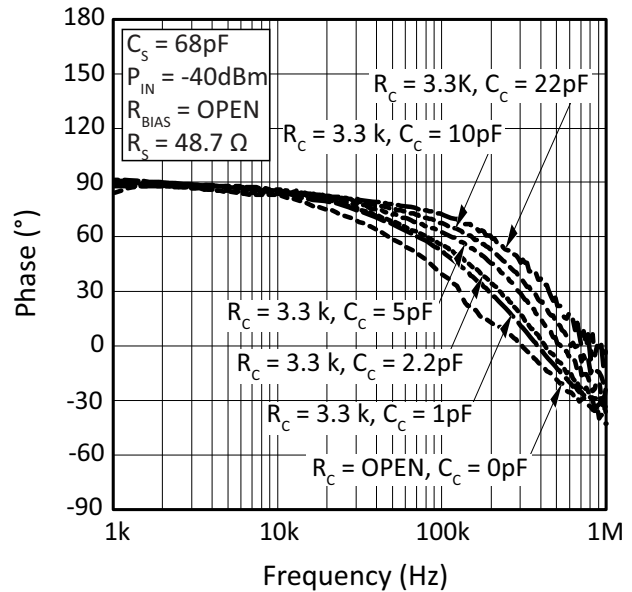

Figure 20: Small Signal Open Loop Phase

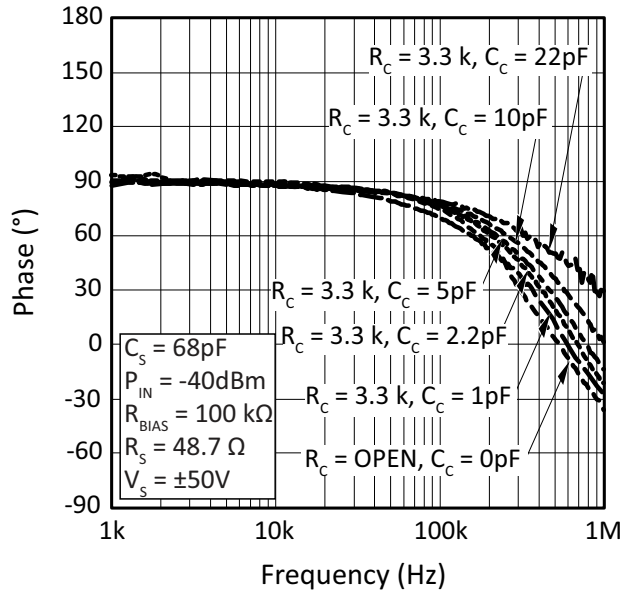

Figure 21: Gain vs. Input/Output Signal Level

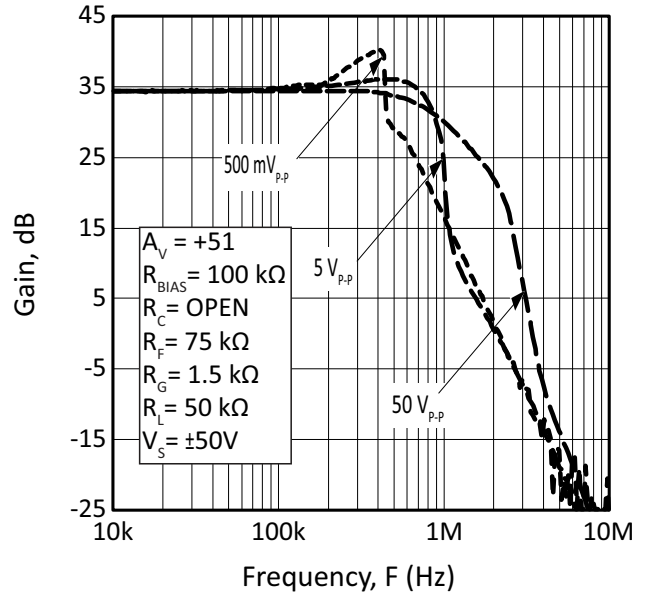

Figure 22: Small Signal Gain vs. Compensation, $V_O=5V_{p-p}$

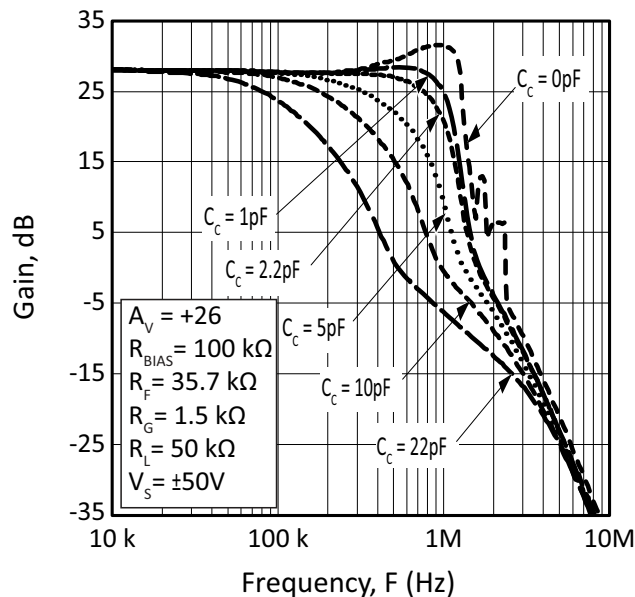

Figure 23: Small Signal Gain vs. Compensation, $V_O=500mV_{p-p}$

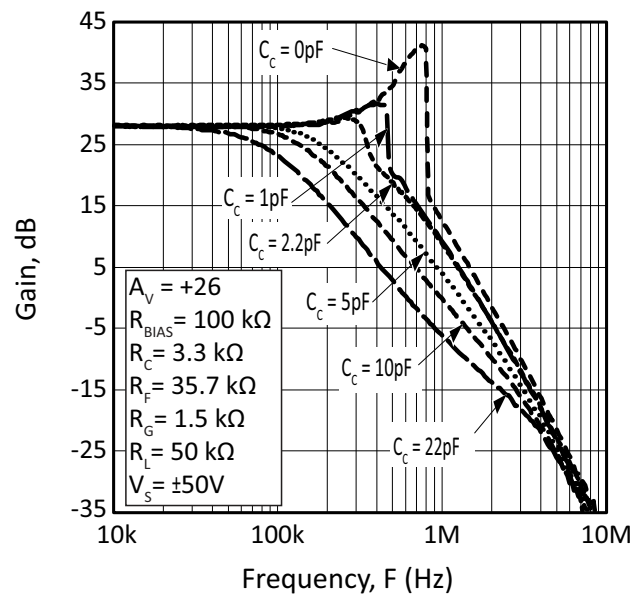

Figure 24: Large Signal Gain vs. Compensation, $V_O=50V_{p-p}$

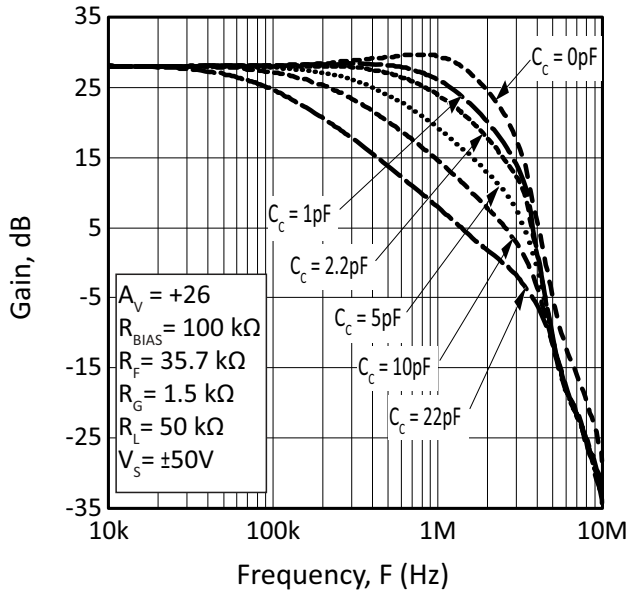

Figure 25: SR+/SR- (25% - 75%)

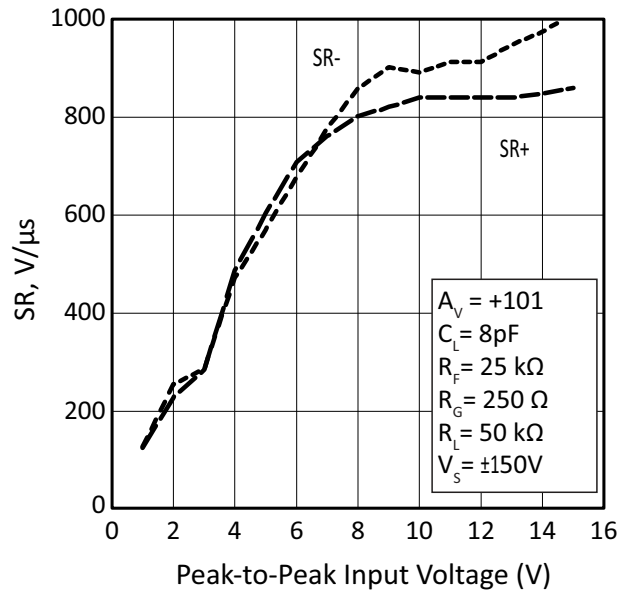

Figure 26: SR+/SR- (25% - 75%)

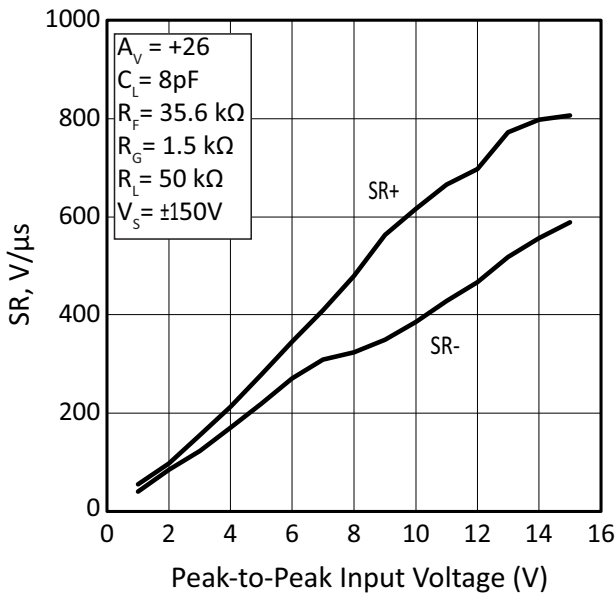

Figure 27: SR+/SR- (25% - 75%)

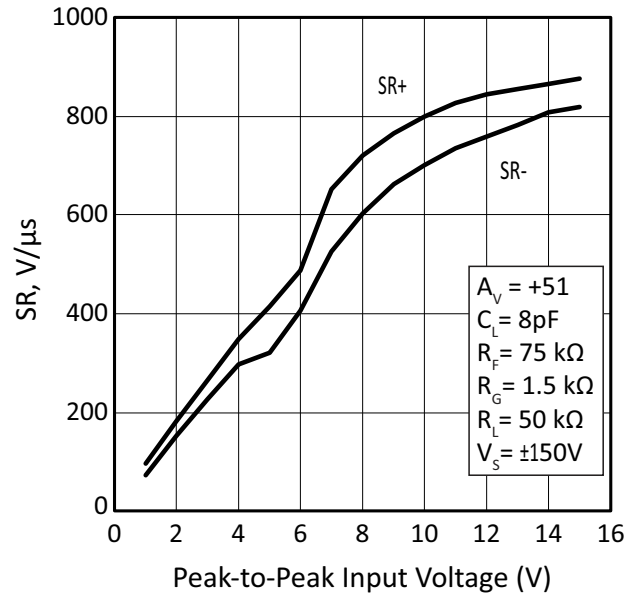

Figure 28: Rise and Fall Time (10% - 90%)

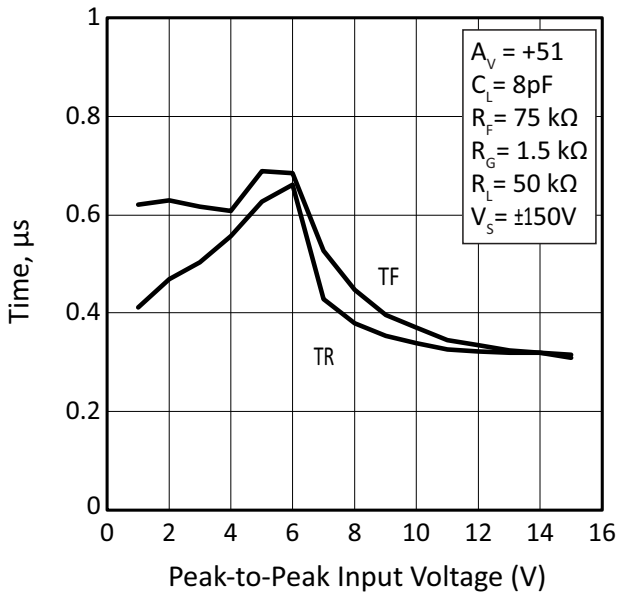

Figure 29: Transient Response

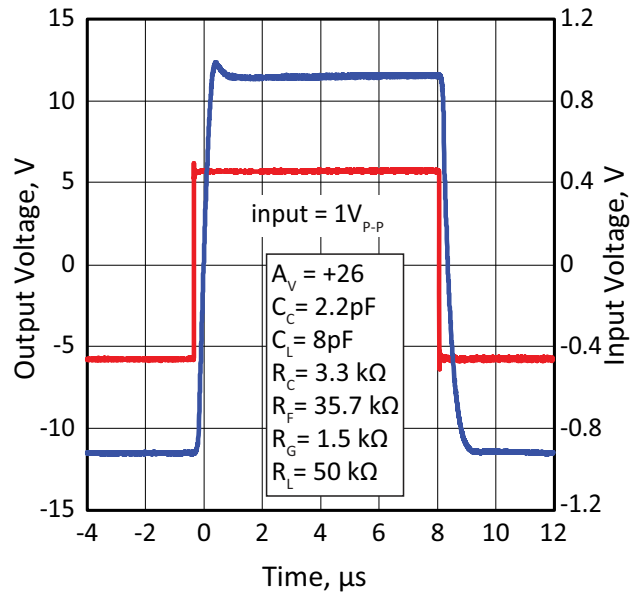

Figure 30: Transient Response

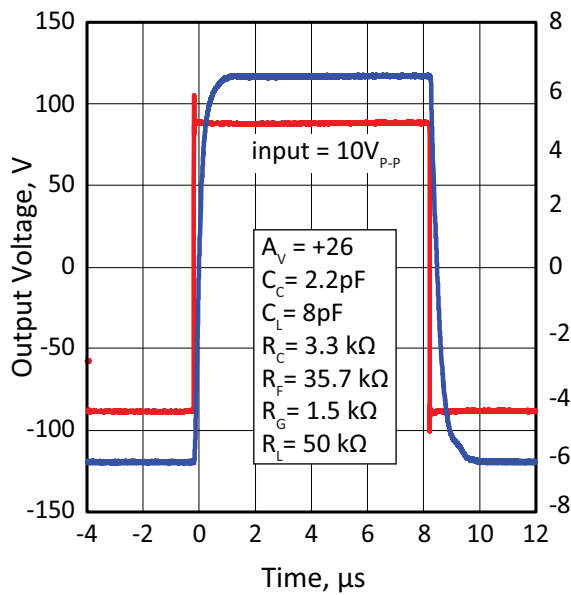

Figure 31: Transient Response

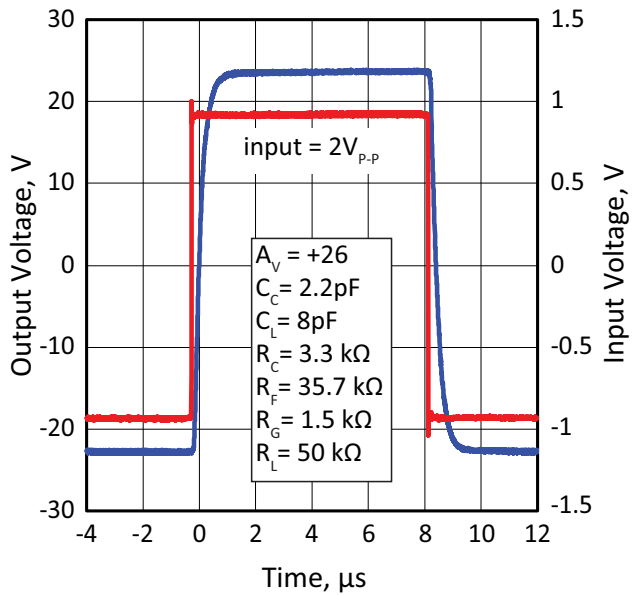

Figure 32: Pulse Response vs. C_C and R_C

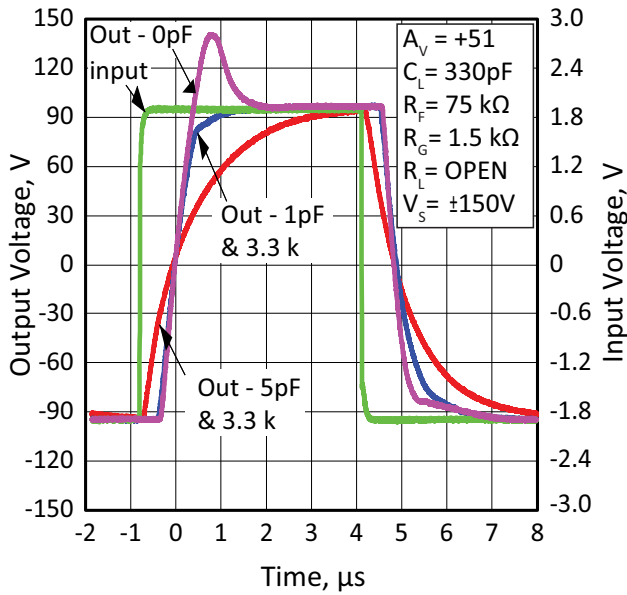

Figure 33: Pulse Response

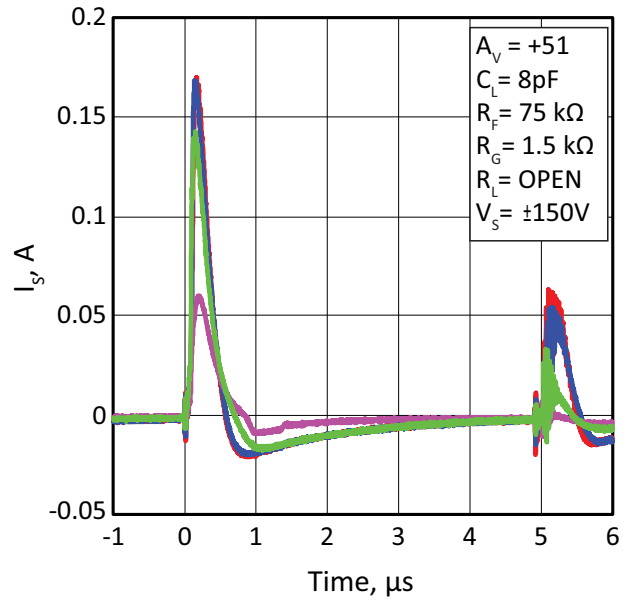

Figure 34: Overdrive Recovery

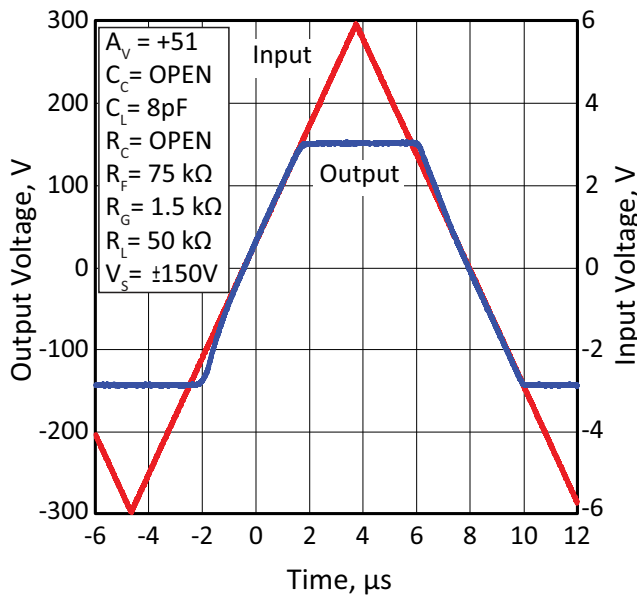

Figure 35: I_S vs. V_{IN}

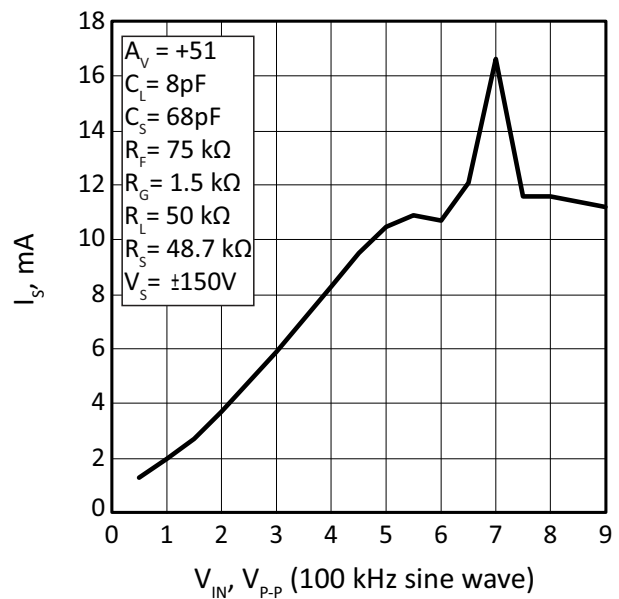

Figure 36: Supply Current vs. Frequency

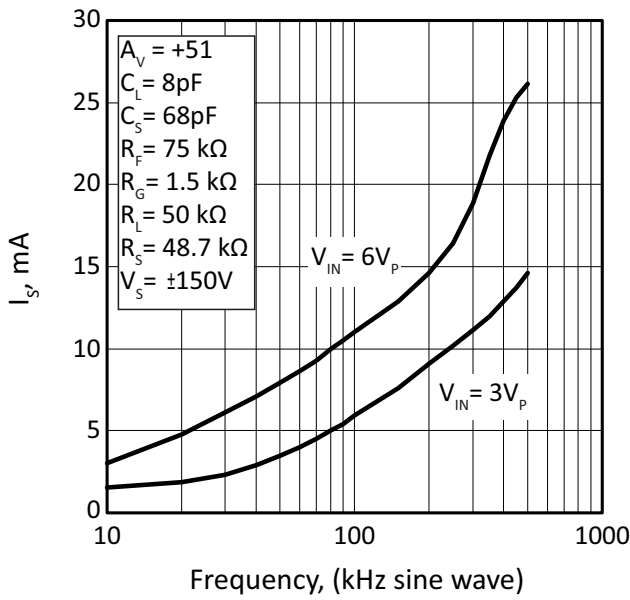

Figure 37: SR+/SR- (25% - 75%)

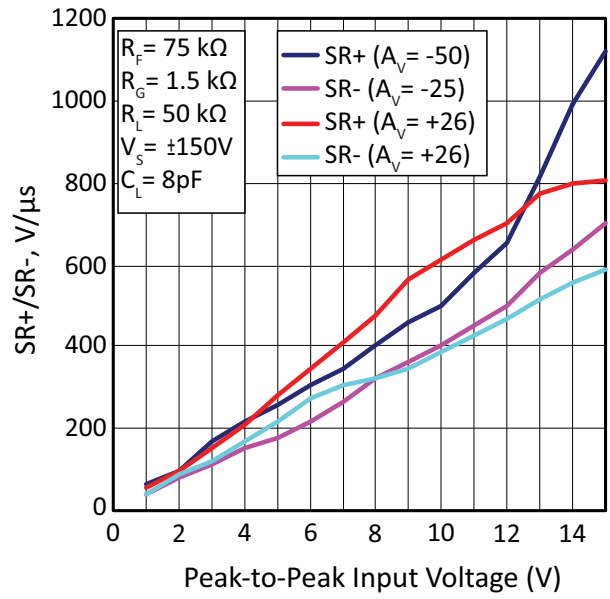
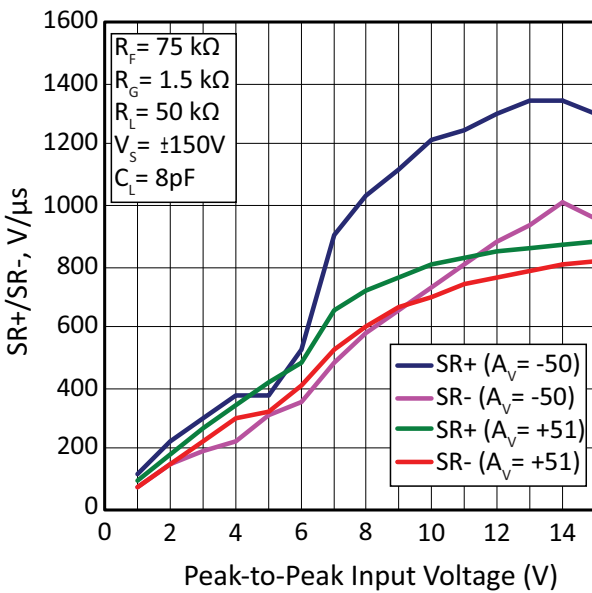

Figure 38: SR+/SR- (25% - 75%)



SAFE OPERATING AREA (SOA)

The MOSFET output stage of the MP400FC is not limited by second breakdown considerations as in bipolar output stages. Only thermal considerations of the package and current handling capabilities limit the Safe Operating Area. The SOA plots include power dissipation limitations which are dependent upon case temperature. Keep in mind that the dynamic current sources which drive high slew rates can increase the operating temperature of the amplifier during periods of repeated slewing. The plot of supply current vs. input signal amplitude for a 100 kHz signal provides an indication of the supply current with repeated slewing conditions. This application dependent condition must be considered carefully.

The output stage is self-protected against transient flyback by the parasitic body diodes of the output stage. However, for protection against sustained high energy flyback, external, fast recovery diodes must be used.

Figure 39: SOA

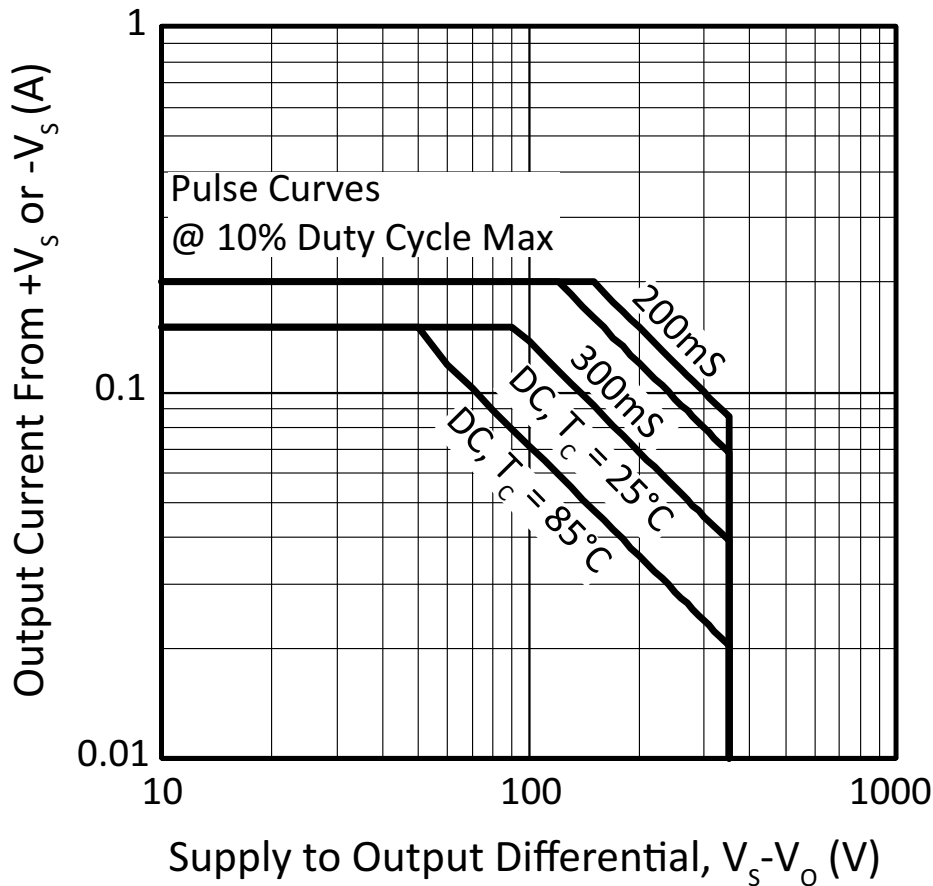

GENERAL

Please read Application Note 1 “General Operating Considerations” which covers stability, supplies, heat sinking, mounting, current limit, SOA interpretation, and specification interpretation. Visit www.apexanalog.com for Apex Microtechnology’s complete Application Notes library, Technical Seminar Workbook, and Evaluation Kits.

TYPICAL APPLICATION

The MP400FC is ideally suited to driving both piezo actuation and deflection applications off of a single low voltage supply. The circuit in figure 40 boosts a system 24 V bus to 350 V to drive an ink jet print head. The MP400FCs high speed deflection amplifier is biased for single supply operation by external resistors R2 – R6, so that a 0 to 5 V DAC can be used as the input to the amplifier to drive the print head from 0 to >300 V. Refer to Apex Application Note 21.

Figure 40: Typical Application

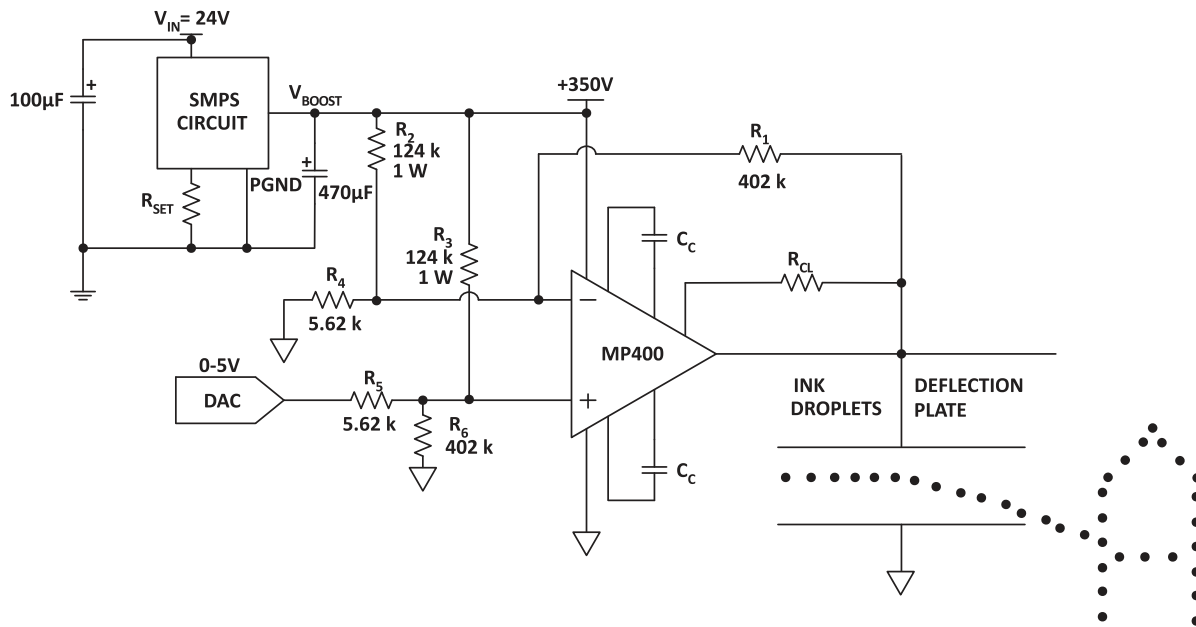

THEORY OF OPERATION

The MP400 is designed specifically as a high speed pulse amplifier. In order to achieve high slew rates with low idle current, the internal design is quite different from traditional voltage feedback amplifiers. Basic op amp behaviors like high input impedance and high open loop gain still apply. But there are some notable differences, such as signal dependent supply current, bandwidth and output impedance, among others. The impact of these differences varies depending on application performance requirements and circumstances. These different behaviors are ideal for some applications but can make designs more challenging in other circumstances.

SUPPLY CURRENT AND BYPASS CAPACITANCE

A traditional voltage feedback amplifier relies on fixed current sources in each stage to drive the parasitic capacitances of the next stage. These currents combine to define the idle or quiescent current of the amplifier. By design, these fixed currents are often the limiting parameter for slew rate and bandwidth of the amplifier. Amplifiers which are high voltage and have fast slew rates typically have high idle currents and dissipate notable power with no signal applied to the load. At the heart of the MP400 design is a signal dependent current source which strikes a new balance between supply current and dynamic performance. With small input signals, the supply current of the MP400 is very low, idling at less than 1 mA. With large transient input signals, the supply currents increase dramatically to allow the amplifier stages to respond quickly. The Pulse Response plot in the typical performance section of this datasheet describes the dynamic nature of the supply current with various input transients.

Choosing proper bypass capacitance requires careful consideration of the dynamic supply currents. High frequency ceramic capacitors of 0.1 μF or more should be placed as close as possible to the amplifier supply pins. The inductance of the routing from the supply pins to these ceramic capacitors will limit the supply of peak current during transients, thus reducing the slew rate of the MP400. The high frequency capacitance should be supplemented by additional bypass capacitance not more than a few centimeters from the amplifier. This additional bypass can be a slower capacitor technology, such as electrolytic, and is necessary to keep the supplies stable during sustained output currents. Generally, a few microfarads is sufficient.

SMALL SIGNAL PERFORMANCE

The small signal performance plots in the typical performance section of this datasheet describe the behavior when the dynamic current sources described previously are near the idle state. The selection of compensation capacitor directly affects the open loop gain and phase performance.

Depending on the configuration of the amplifier, these plots show that the phase margin can diminish to very low levels when left uncompensated. This is due to the amount of bias current in the input stage when the part is in standby. An increase in the idle current in the output stage of the amplifier will improve phase margin for small signals although will increase the overall supply current.

Current can be injected into the output stage by adding a resistor, R_{BIAS} , between pins 42 and 4. The size of R_{BIAS} will depend upon the application but 500 μA (50 V V_+ supply/100K) of added bias current shows significant improvement in the small signal phase plots. Adding this resistor has little to no impact on small signal gain or large signal performance as under these conditions the current in the input stage is elevated over its idle value. It should also be noted that connecting a resistor to the upper supply only injects a fixed current and if the upper supply is fixed and well bypassed. If the application includes variable or adjustable supplies, a current source diode could also be used. These two terminal components combine a JFET and resistor connected within the package to behave like a current source.

As a second stability measure, the MP400 is externally compensated and performance can be optimized to the application. Unlike the R_{BIAS} technique, external phase compensation maintains the low idle current but does affect the large signal response of the amplifier. Refer to the small and large signal response plots as a guide in making the tradeoffs between bandwidth and stability. Due to the unique design of the MP400, two symmetric compensation networks are required. The compensation capacitor C_C must be rated for a working voltage of the full operating supply voltage ($+V_S$ to $-V_S$). NPO capacitors are recommended to maintain the desired level of compensation over temperature.

LARGE SIGNAL PERFORMANCE

As the amplitude of the input signal increases, the internal dynamic current sources increase the operation bandwidth of the amplifier. This unique performance is apparent in its slew rate, pulse response, and large signal performance plots. Recall the previous discussion about the relationships between signal amplitude, supply current, and slew rate. As the amplitude of the input amplitude increases from 1 V_{p-p} to 15 V_{p-p}, the slew rate increases from 50 V/μs to well over 350 V/μs.

Notice the knee in the Rise and Fall times plot, at approximately 6 V_{p-p} input voltage. Beyond this point the output becomes clipped by the supply rails and the amplifier is no longer operating in a closed loop fashion. The rise and fall times become faster as the dynamic current sources are providing maximum current for slewing. The result of this amplifier architecture is that it slews fast, and allows good control of overshoot for large input signals. This can be seen clearly in the large signal Transient Response plots.

CURRENT LIMIT

For proper operation, the current limit resistor, R_{LIM}, must be connected as shown in the typical connection diagram. For maximum reliability and protection, the largest resistor value should be used. The maximum practical value for R_{LIM} is about 12 Ω. However, refer to the SOA curve to assist in selecting the optimum value for R_{lim} in the intended application. Current limit may not protect against short circuit conditions with supply voltages over 200 V.

LAYOUT CONSIDERATIONS

Care should be taken to position the R_C / C_C compensation networks close to the amplifier compensation pins. Long loops in these paths pick up noise and increase the likelihood of LC interactions and oscillations.

SMPS OPERATION

Figure 41: SMPS Output vs. RSET

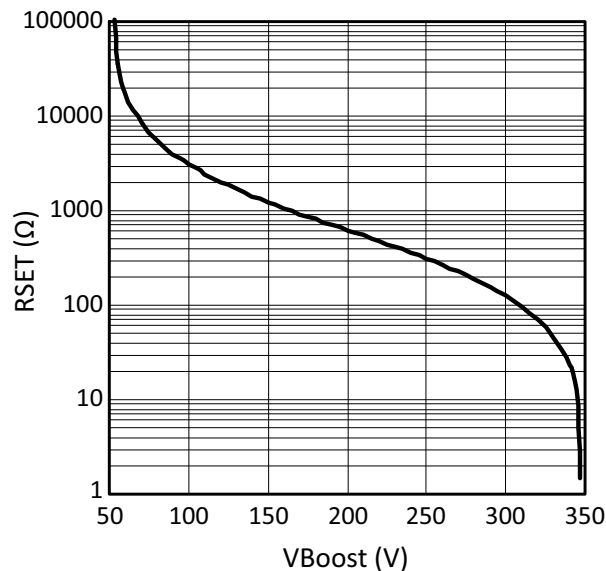

The MP400FC is designed to operate off of a standard voltage rail. Typical values include 12 V, 24 V, or 48 V. The addition of the on-board SMPS eliminates the need to design or purchase a high voltage power supply. The only inputs required by the SMPS are the V_{IN} source. Input and output filter capacitor, and boost voltage set resistor (R_{SET}).

The SMPS output can be adjusted between a minimum of 50 V to a maximum of 350 V. The voltage boost adjustment is independent of V_{IN} . Adjustment to the boost level is made through a resistor from the R_{SET} pin to ground. The resistor value is:

$$R_{SET} = \frac{1.85 \cdot 10^5}{V_{BOOST} - 49.95} - 615$$

Where V_{BOOST} = desired SMPS voltage.

Example:

1. Desired $V_{BOOST} = 160$ V
2. $R_{SET} = 1k$ (1066 by equation)

If R_{SET} is open, V_{BOOST} will be 50 V. If R_{SET} is shorted to ground V_{BOOST} will be limited to 350 V.

Note that while the MP400 SMPS generates a positive voltage from 50 V to 350 V, the amplifier may operate from a variety of supply voltages. Symmetric, asymmetrical and single supply configurations can be used so long as the total supply voltage from $+V_S$ to $-V_S$ does not exceed 350 V. The amplifier performance graphs in this datasheet include some plots taken with symmetrical supplies, but those plots generally apply to all supply configurations.

SMPS OUTPUT CAPACITOR

An external SMPS output filter capacitor is required for proper operation. ESR considerations prevail in the choice of the output filter capacitor. Select the highest value capacitor that meets the following ESR requirement. The minimum value for C_{BOOST} is 100 μ F.

$$ESR = \frac{dV_o}{I_{LPK}}$$

Where:

dV_o = The maximum acceptable output ripple voltage

I_{LPK} = Peak inductor current = $(1/L) \cdot V_{IN} \cdot ton$

$L = 10^{-6}$ if the internal inductor is used.

V_{IN} = Input voltage of the application.

$ton = \sqrt{2 \cdot I_o \cdot L \cdot ((V_{BOOST} + 0.6 - V_{IN}) / (F_{SW} \cdot V_{IN}^2))}$

V_{BOOST} = The boost supply voltage of the application.

I_o = The maximum continuous output current for the application.

F_{SW} = 100 kHz switching frequency of the MP400FC boost supply.

SMPS INPUT CAPACITOR

An external input capacitor is required. This capacitor should be at least 100 μ F.

THERMAL CONSIDERATIONS

For reliable operation the MP400FC will require a heatsink for most applications. When choosing the heatsink the power dissipation in the op amp and the SMPS MOSFET switch (Q2) are both considered. The power dissipation of the op amp is determined in the same manner as any power op amp. The power dissipation of the MOSFET switch (Q2) is the sum of the power dissipation due to conduction and the switching power.

$$P_{D(Q2)} = (I_{IN(pk)}^2 \cdot R_{DS(ON)} \cdot D) + (I_{IN(pk)} \cdot V_{IN} \cdot t_r \cdot F_{SW})$$

Where:

V_{IN} = SMPS input voltage

V_B = SMPS output voltage

I_O = Total SMPS output current

F_{SW} = 100 kHz

$R_{DS(ON)}$ = 0.621 Ω

t_r = 82 x 10⁻⁹s

D = $t_1 \cdot F_{SW}$

$$t_1 = \sqrt{2 \cdot I_O \cdot 10 \times 10^{-6} \cdot \left(\frac{V_B - V_{IN}}{F_{SW} \cdot V_{IN}^2} \right)}$$

$$I_{IN(pk)} = \frac{V_B \cdot t_d}{10 \times 10^{-6}}$$

$$t_d = t_1 \cdot \left(\frac{V_B}{V_B - V_{IN}} \right) - t_1$$

MP400FC

PACKAGE OPTIONS

| Part Number | Apex Package Style | Description |
|-------------|--------------------|-------------|
| MP400FC | FC | 42-pin DIP |

PACKAGE STYLE FC

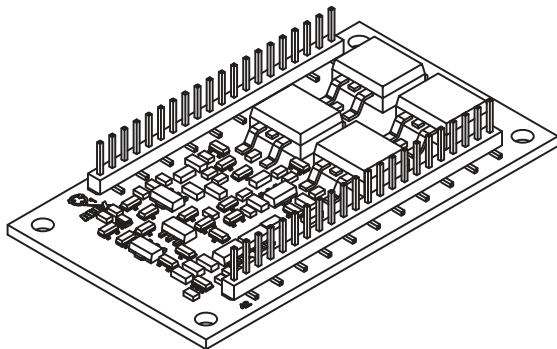
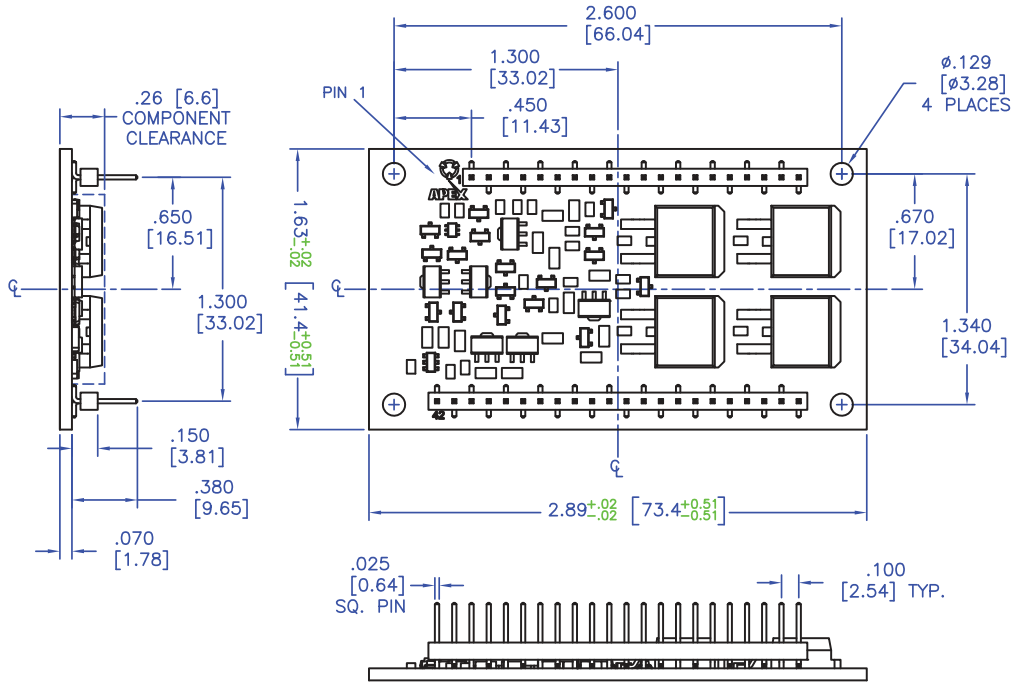

NOTES:

1. Dimensions are inches; alternate units are [mm].
2. Recommended PCB hole diameter for pins: .050 [1.27].
3. 2oz. copper over 600V dielectric over aluminum substrate.
4. Tin over nickel plated phosphor bronze pins.
5. Package weight:
6. Mount with #4 or equivalent screws.
7. It is not recommended that mounting of the package rely on the pins for mechanical support.

NEED TECHNICAL HELP? CONTACT APEX SUPPORT!

For all Apex Microtechnology product questions and inquiries, call toll free 800-546-2739 in North America. For inquiries via email, please contact apex.support@apexanalog.com. International customers can also request support by contacting their local Apex Microtechnology Sales Representative. To find the one nearest to you, go to www.apexanalog.com

IMPORTANT NOTICE

Apex Microtechnology, Inc. has made every effort to insure the accuracy of the content contained in this document. However, the information is subject to change without notice and is provided "AS IS" without warranty of any kind (expressed or implied). Apex Microtechnology reserves the right to make changes without further notice to any specifications or products mentioned herein to improve reliability. This document is the property of Apex Microtechnology and by furnishing this information, Apex Microtechnology grants no license, expressed or implied under any patents, mask work rights, copyrights, trademarks, trade secrets or other intellectual property rights. Apex Microtechnology owns the copyrights associated with the information contained herein and gives consent for copies to be made of the information only for use within your organization with respect to Apex Microtechnology integrated circuits or other products of Apex Microtechnology. This consent does not extend to other copying such as copying for general distribution, advertising or promotional purposes, or for creating any work for resale.

APEX MICROTECHNOLOGY PRODUCTS ARE NOT DESIGNED, AUTHORIZED OR WARRANTED TO BE SUITABLE FOR USE IN PRODUCTS USED FOR LIFE SUPPORT, AUTOMOTIVE SAFETY, SECURITY DEVICES, OR OTHER CRITICAL APPLICATIONS. PRODUCTS IN SUCH APPLICATIONS ARE UNDERSTOOD TO BE FULLY AT THE CUSTOMER OR THE CUSTOMER'S RISK.

Apex Microtechnology, Apex and Apex Precision Power are trademarks of Apex Microtechnology, Inc. All other corporate names noted herein may be trademarks of their respective holders.